



More Precision.

thermoIMAGER TIM
Compact Thermal Imager



thermoIMAGER TIM 160

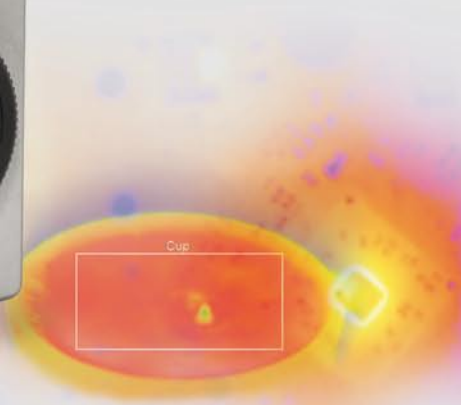

thermoIMAGER TIM 160

Miniature real time thermal imager with USB interface

- Measuring range from -20°C to 900°C (special edition 1500°C)
- Excellent thermal sensitivity of 0.08K (NEDT)
- Exchangeable lenses with 6°FOV, 23°FOV, 48°FOV and 80°FOV
- Real time video recording at 120Hz frame rate with slow motion playback capability
- Power supply and operation via USB 2.0 interface
- Extremely lightweight (195g) and rugged (IP67)
- Very compact 45x45x62mm
- Analogue input and output, trigger interface
- Software developer kit and Labview driver are included as standard

Software

- Display of the thermal image in real time (120Hz) with recording function (video, snap shot)
- Complete set up of parameters and remote control of the camera
- Detailed analysis of fast thermodynamic processes
- Output of analogue temperature or alert values via the process interface
- Digital communication via RS232 or DLL for software integration

Applications - Examples

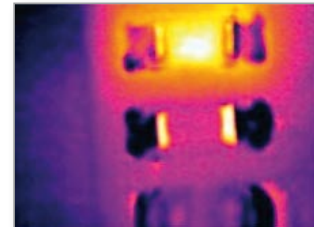

R&D electronic

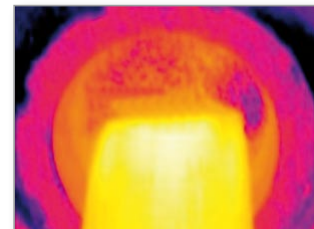

Process control extrusion

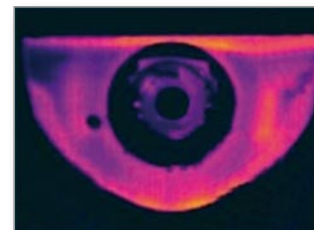

R&D mechanical components

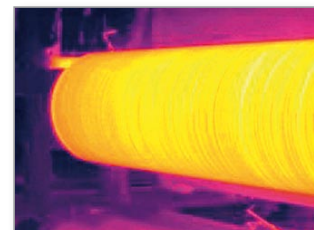

Process control calendaring

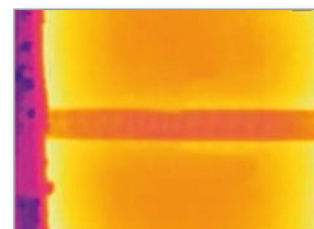

Production of solar panels

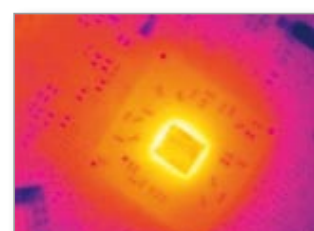

R&D electronic devices

Technical data

thermoIMAGER TIM 160

Optical resolution	160x120 pixel
Temperature ranges	-20°C to 100°C / 0°C to 250°C / 150°C to 900°C
Spectral range	7.5 to 13µm
Frame rate	120Hz
System accuracy	±2% or ±2°C
Resolution (Display)	±0.1°C
Lenses	80° / f = 3.1mm (min. distance 20mm); 48° / f = 4.5mm (min. distance 20mm); 23° / f = 10mm (min. distance 20mm); 6° / f = 35.5mm (min. distance 500mm)
Emissivity	0.10 to 1.00 adjustable
Thermal Sensitivity	0.1K with 48° FOV and 80° FOV ¹⁾ / 0.08K with 23° FOV ¹⁾ / 0.3K with 6° FOV ²⁾
Detector	Focal Plane Array (FPA) - uncooled micro bolometer 25x25µm ²
Measurement modes	Flexible spot with crosshair marking, fixed measurement field with automatic display of maximum-, minimum- or average value
Colour palettes	Iron, rainbow, black-white, black-white inverted
Set up controls (via menu)	Mesurement modes, full automatic, manual, colour palettes, emissivity, file management, date/time, °C/ °F, language
Outputs/digital	USB 2.0
Process interface (electrically isolated)	0-10 V output, 0-10 V input, trigger input
Digital communication	via RS232 of PC / DLL interface
Cable length	1m (standard), 5m, 10 m, 20m
Power supply	USB powered
Tripod mount	1/4-20 UNC
Environmental rating	IP 67
Ambient temperature	0°C to 50°C (up to 240°C with cooling jacket)
Storage temperature	-40°C to 70°C
Relative humidity	20 to 80%, non-condensing
Vibration	2G, IEC 68-2-6 11-200Hz each axis
Shock	25G, IEC 68-2-29 11ms each axis
Weight	195g; incl. lens

PC requirements: minimum 1.5GHz, 1GB RAM, Windows XP SP2, Windows 7

¹⁾ Caution: at distances below 200mm measurement accuracy can be out of specification

²⁾ Caution: at distances below 500mm measurement accuracy can be out of specification

Dimensions

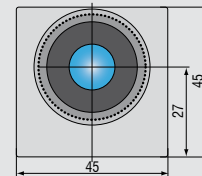
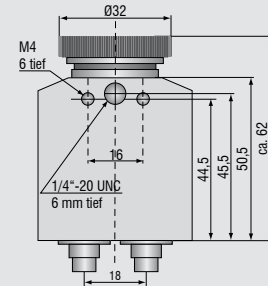

Accessories

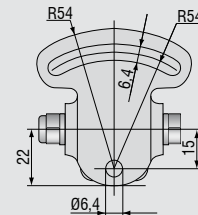

TM-MB-TIM Mounting base, adjustable

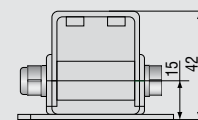

TM-PH-TIM Protective housing incl. mounting base



TM-J-TIM Cooling jacket
(length 228mm, ø89mm) with adjustable
mounting bracket TM-JAB-TIM;
recommended high temperature cable
TM-USBC5H-TIM (up to 240°C)

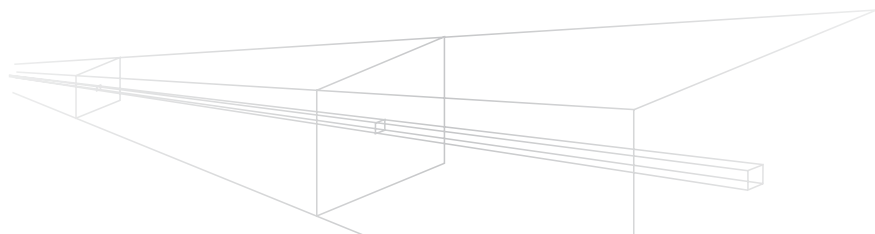

The right optics for many applications

thermoIMAGER TIM 160/200

Objective 80° x 60° wide angle; focal distance 3.1mm; min distance 0.1m												
HFOV	m	0.13	0.26	0.39	0.65	1.55	2.58	5.16	7.7	12.9	38.7	129.0
VFOV	m	0.09	0.19	0.29	0.48	1.16	1.94	3.87	5.8	9.7	29.0	96.8
IFOV	mm	0.81	1.61	2.42	4.03	9.68	16.13	32.26	48.4	80.7	241.9	806.5
<i>Distance in m</i>		0.1	0.2	0.3	0.5	1.2	2	4	6	10	30	100

Objective 48° x 37° wide angle; focal distance 4.5mm; min distance 0.02m												
HFOV	m	0.09	0.18	0.27	0.44	1.07	1.78	3.56	5.3	8.9	26.7	88.9
VFOV	m	0.07	0.13	0.20	0.33	0.80	1.33	2.67	4.0	6.7	20.0	66.7
IFOV	mm	0.56	1.11	1.67	2.78	6.67	11.11	22.22	33.3	55.6	166.7	555.6
<i>Distance in m</i>		0.1	0.2	0.3	0.5	1.2	2	4	6	10	30	100

- Standard-, tele- and wide angle lens for different applications
- High quality germanium lenses and a special antireflective coating
- Factory calibrated lenses allowing the easy exchange of optics without recalibration

Objective 23° x 17° wide angle; focal distance 10mm; min distance 0.02m												
HFOV	m	0.04	0.08	0.12	0.20	0.48	0.80	1.60	2.40	4.00	12.00	40.00
VFOV	m	0.03	0.06	0.09	0.15	0.36	0.60	1.20	1.80	3.00	9.00	30.00
IFOV	mm	0.25	0.50	0.75	1.25	3.00	5.00	10.00	15.00	25.00	75.00	250.00
<i>Distance in m</i>		0.1	0.2	0.3	0.5	1.2	2	4	6	10	30	100

Objective 6° x 5° wide angle; focal distance 35.5mm; min distance 0.5m												
HFOV	m	-	-	-	0.06	0.14	0.23	0.45	0.7	1.1	3.4	11.3
VFOV	m	-	-	-	0.04	0.10	0.17	0.34	0.5	0.8	2.5	8.5
IFOV	mm	-	-	-	0.35	0.85	1.41	2.82	4.2	7.0	21.1	70.4
<i>Distance in m</i>		0.1	0.2	0.3	0.5	1.2	2	4	6	10	30	100

FOV = Field of view; HFOV = Horizontal field of view; VFOV = Vertical field of view; IFOV = Indicated field of view

thermoIMAGER TIM 400/450

Objective 30° x 23°; focal distance 17mm; min distance 0.2m												
HFOV	m	0.11	0.17	0.28	0.67	1.12	1.60	3.4	5.6	16.9	56.2	
VFOV	m	0.08	0.13	0.21	0.51	0.84	1.20	2.5	4.2	12.7	42.4	
IFOV	mm	0.29	0.44	0.74	1.76	2.94	5.88	8.8	14.7	44.1	147.1	
<i>Distance in m</i>		0.2	0.3	0.5	1.2	2	4	6	10	30	100	

Objective 13° x 10° Tele; focal distance 40mm; min distance 0.5m												
HFOV	m			0.12	0.29	0.48	0.96	1.5	2.4	7.2	23.9	
VFOV	m			0.09	0.22	0.36	0.72	1.1	1.8	5.4	18.0	
IFOV	mm			0.31	0.75	1.25	2.50	3.8	6.3	18.8	62.5	
<i>Distance in m</i>				0.5	1.2	2	4	6	10	30	100	

FOV = Field of view; HFOV = Horizontal field of view; VFOV = Vertical field of view; IFOV = Indicated field of view

Note: The accuracy of measurement can be outside of the specifications for distances below 0.2m.

Precise measurement values can be calculated on
www.micro-epsilon.com/optikkalkulator



Dependence between field of view (FOV) and distance
 Example: (lens 23° x 17°)

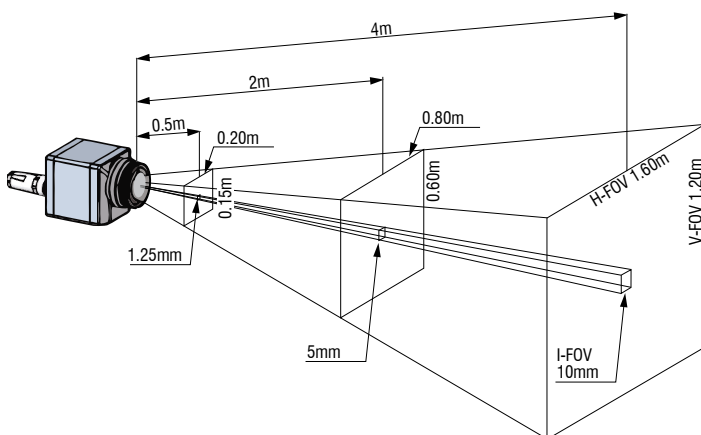

Scope of supply

TIM 160/200

- ▶ TIM process camera including one selected lens
- ▶ Operation manual
- ▶ USB cable 1m
- ▶ Processing and analysing software
- ▶ Tripod mount
- ▶ PIF cable 1m

TIM 160/200 /DK

- ▶ TIM process camera including 6°, 23°, 48° optics
- ▶ Certificate of calibration, matched with the optics
- ▶ Tripod mount 200 to 1000mm
- ▶ Rugged transport case
- ▶ Operation manual
- ▶ USB cable 1m and 10m
- ▶ Processing and analysing software
- ▶ PIF cable 1m

TIM 400/450

- ▶ TIM process camera including one selected lens
- ▶ USB cable 1m
- ▶ Processing and analysing software
- ▶ Tripod mount
- ▶ PIF cable 1m
- ▶ Aluminium case

High performance sensors made by Micro-Epsilon



Sensors and systems for displacement and position



Sensors and measurement devices for non-contact temperature measurement



2D/3D profile sensors (laser scanner)

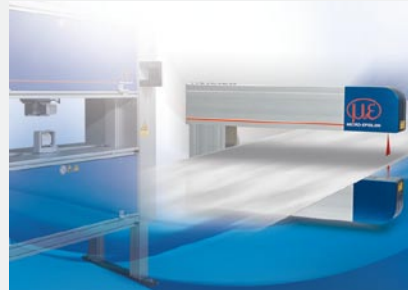

Measurement and inspection systems for quality assurance



Optical micrometers, fiber optic sensors and optical fibers



Color recognition sensors, LED analyzers and color online spectrometer



MICRO-EPSILON Headquarters

Koenigbacher Str. 15 · 94496 Ortenburg / Germany
Tel. +49 (0) 8542 / 168-0 · Fax +49 (0) 8542 / 168-90
info@micro-epsilon.com · www.micro-epsilon.com

MICRO-EPSILON UK Ltd.

Unit 1 Pioneer Business Park · Ellesmere Port · CH65 1AD
Phone +44 (0) 151 355 6070
info@micro-epsilon.co.uk · www.micro-epsilon.co.uk

MICRO-EPSILON USA

8120 Brownleigh Dr. · Raleigh, NC 27617 / USA
Phone +1/919/787-9707 · Fax +1/919/787-9706
me-usa@micro-epsilon.com · www.micro-epsilon.com